



# Architectural & Acoustic Masonry Solutions

**Colinwell**   
Masonry & Retaining Wall Products



▲ Product: Colinwell Split Face Masonry  
Colour: Cinder Blend

# Contents

- About Colinwell 3
- Why Choose Architectural Masonry from Colinwell? 4
- The Colinwell Architectural Masonry Collection 6
- Smooth Face Masonry 16
- Split Face Masonry 18
- Sound Absorbing Masonry 19
- Technical Information & Installation Guidance 22
- Paint Grade Masonry 28
- Our Accreditations 35



▲ Product: Colinwell Smooth and Split Face Masonry  
Colour: Cream

## About Colinwell

Colinwell, a RTU company, is an award-winning company and a market leader in the concrete products industry. With over 130 years of experience, Colinwell has earned a strong reputation for producing best-in-class concrete products that combine performance, durability, and design excellence.

Our diverse product range includes Allan Block Retaining Wall Systems, Martello Stone Walling, Architectural Masonry, and Acoustic Masonry Solutions. These innovative systems are designed to meet the needs of a wide variety of projects, providing both functional and aesthetic value.

Colinwell proudly serves a broad range of sectors, including education, industrial, infrastructure, residential, commercial, sports and recreation, and religious developments. Our ability to deliver dependable and tailored solutions has made us a trusted name across these industries.

We ensure our clients receive the right products, at the right time, and in the right place – backed by expert support and a deep understanding of construction needs. We supply projects of all sizes throughout the UK & Ireland, offering nationwide delivery and service our clients can rely on.

Our vision is to be the leading supplier of concrete masonry products – a goal we pursue through our core values of innovation, passion, and quality.

We are committed to sustainability, integrating environmentally conscious practices across our manufacturing processes and product designs. Colinwell continues to build on its legacy of excellence, combining heritage, innovation, and quality in every product we deliver.



## Why Choose Architectural Masonry from Colinwell?



### Robust and Reliable Finish

Our architectural masonry offers a strong, durable finish designed to stand the test of time. Engineered for resilience, it provides structural integrity without compromising on aesthetic appeal.



### Versatile Surface Options

Choose from a variety of finishes including split face and smooth face, allowing you to tailor the look to your project's unique style and design requirements.



### Exceptional Weather Resistance

Designed to effectively withstand the elements, our masonry resists weathering while improving in character over time. This natural aging process enhances the material's visual appeal while maintaining its performance.



### Longevity that Spans Decades

Built to last, Colinwell's architectural masonry delivers enduring strength and beauty for decades.

# The Colinwell Architectural Masonry Collection

▲ Product: Colinwell Acousta Tex Acoustic Masonry  
Colour: Green



▲ Product: Colinwell Smooth Face Masonry  
Colour: Cream

Discover a carefully curated range of architectural masonry colours designed to inspire and elevate your projects. Each option in the Colinwell Architectural Masonry Collection combines timeless elegance with modern durability, offering the perfect finish to bring your vision to life.

Our collection also features colour blend masonry, blending carefully selected tones to add depth, texture, and unique character to your building's exterior.

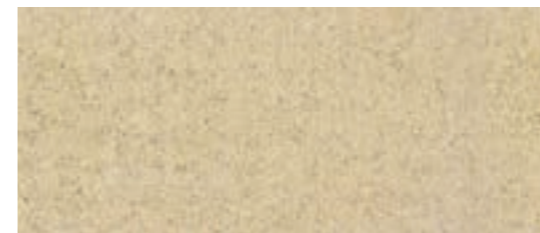

Cream - Smooth Face

Price Band - C



Green - Smooth Face

Price Band - D



Cream - Split Face

Price Band - C

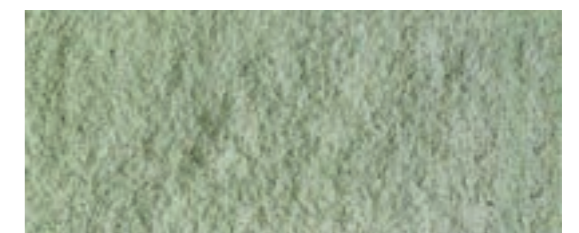

Green - Split Face

Price Band - D

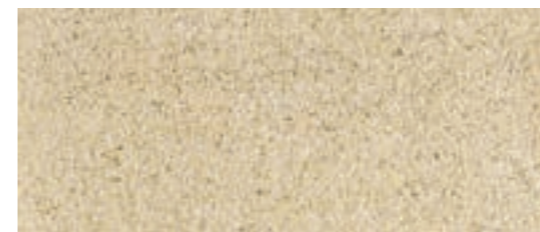

Cream - Shot Blasted

Price Band - C



Green - Shot Blasted

Price Band - D



▲ Product: Colinwell Smooth & Split Face Masonry  
Colours: White & Whinstone



▲ Product: Colinwell Smooth Face Masonry  
Colour: Sandstone

▼ Product: Colinwell Split Face Masonry  
Colour: White



White - Smooth Face

Price Band - C

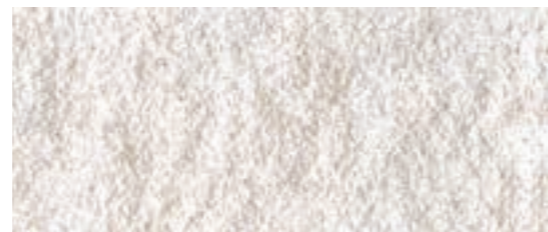

White - Split Face

Price Band - C

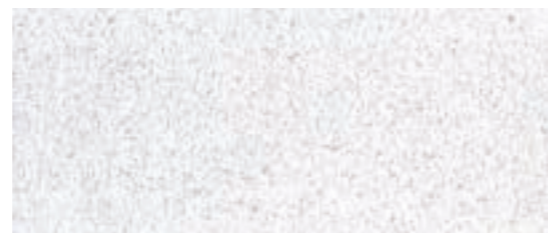

White - Shot Blasted

Price Band - C



Sandstone - Smooth Face

Price Band - B



Sandstone - Split Face

Price Band - B

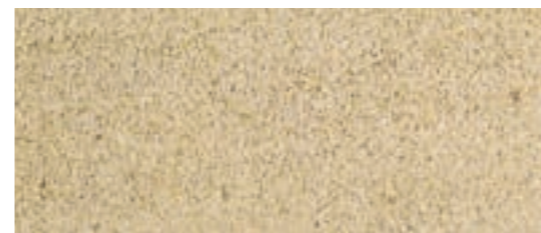

Sandstone - Shot Blasted

Price Band - B

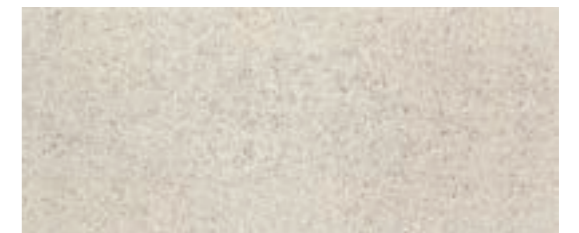

Portland - Smooth Face

Price Band - B

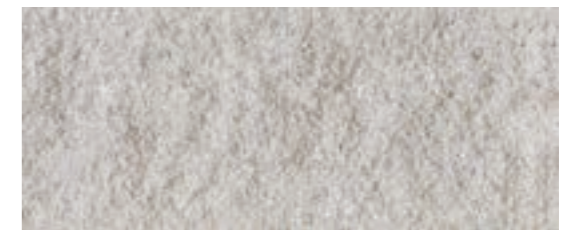

Portland - Split Face

Price Band - B



Portland - Shot Blasted

Price Band - B



▲ Product: Colinwell Split Face Masonry  
Colour: Natural



▲ Product: Colinwell Split Face Masonry  
Colour: Straw

▼ Product: Colinwell Smooth and Split Face Masonry  
Colour: Natural

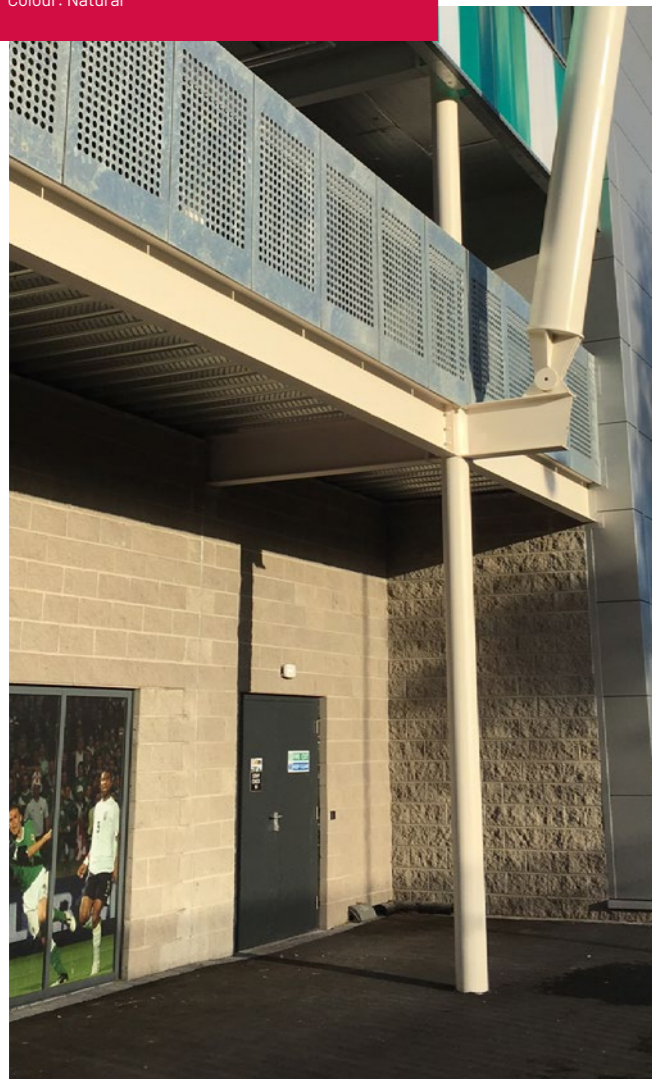

Natural - Smooth Face Price Band - A



Natural - Split Face Price Band - A



Natural - Shot Blasted Price Band - A



Straw - Smooth Face Price Band - A



Straw - Split Face Price Band - A



Straw - Shot Blasted Price Band - A



Bracken - Smooth Face Price Band - A



Bracken - Split Face Price Band - A



Bracken - Shot Blasted Price Band - A



▲ Product: Colinwell Smooth & Split Face Masonry  
Colour: Sandstone



▲ Product: Colinwell Smooth Face Masonry  
Masonry Colour: Whinstone



Red - Smooth Face Price Band - A



Honey - Smooth Face Price Band - A



Whinstone - Smooth Face Price Band - A



Buff - Smooth Face Price Band - A

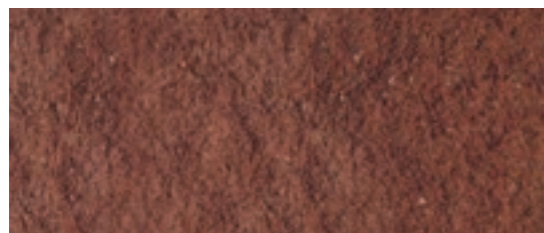

Red - Split Face Price Band - A



Honey - Split Face Price Band - A



Whinstone - Split Face Price Band - A



Buff - Split Face Price Band - A



Red - Shot Blasted Price Band - A

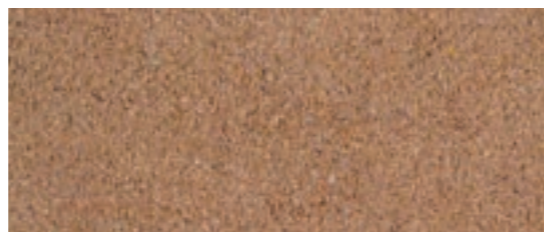

Honey - Shot Blasted Price Band - A



Whinstone - Shot Blasted Price Band - A



Buff - Shot Blasted Price Band - A



▲ Product: Colinwell Colour Blend Split Face Masonry  
Colour: Cinder Blend



▲ Product: Colinwell Smooth & Split Face Masonry  
Colour: Honey, Cream & Whinstone



Slate Blend Price Band - A



Yorkstone Blend Price Band - A



Abbey Blend Price Band - A



Cinder Blend Price Band - A

# Smooth Face Masonry



▲ Product: Colinwell Smooth & Split Face Masonry  
Colour: Natural & Whinstone



▲ Product: Colinwell Smooth & Split Face Masonry  
Colour: Portland & Whinstone

All dimensions shown are in millimetres. Block definitions are in accordance with BS EN 771-3.  
Co-ordinating Size Range  
450mm x 225mm 10 blocks per sq metre.

## Solid Units

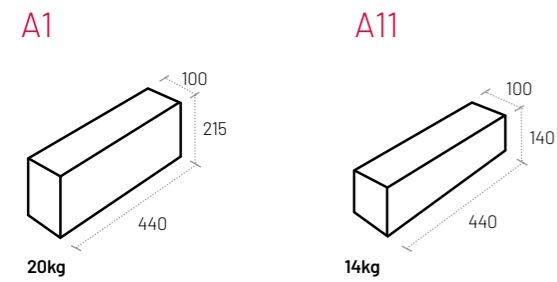

## Cellular Units

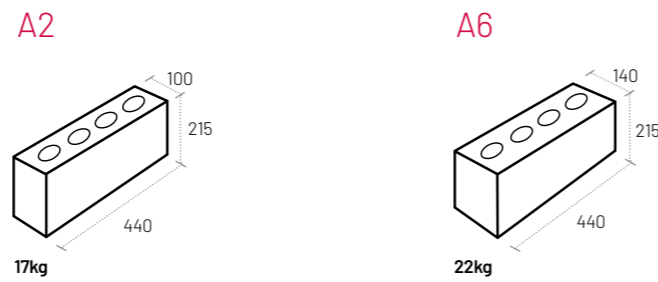

## Half Length Units

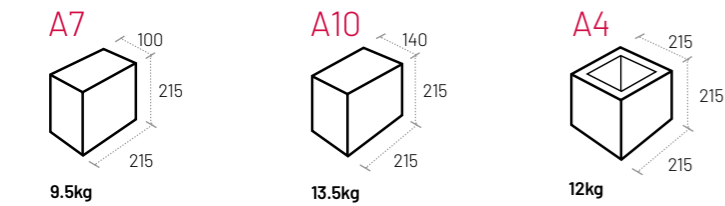

## Hollow Units

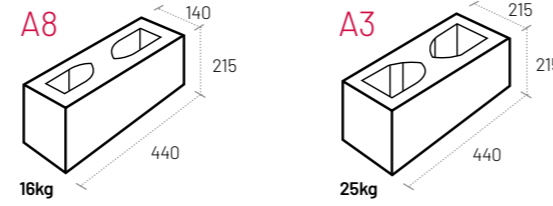

## Quoin Units

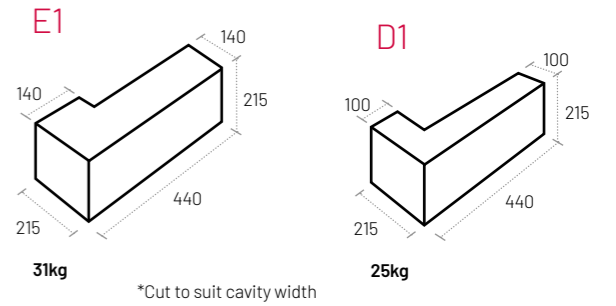

## Squint Units

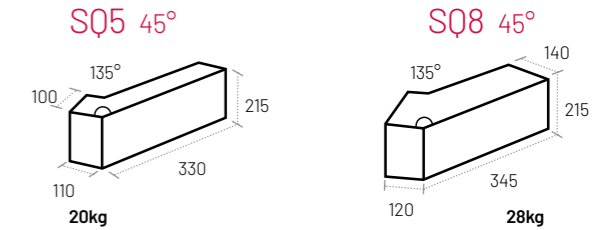

## Rebated Lintel Units

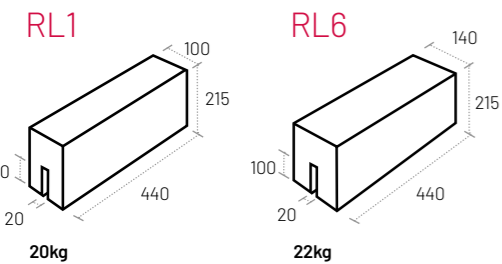

## Half Length Cill Units

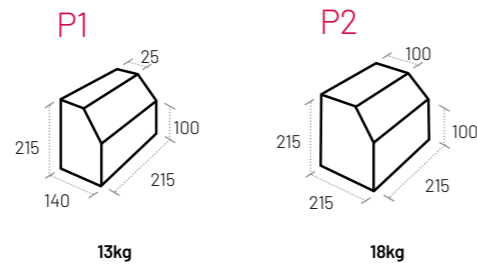

## Cill Corner

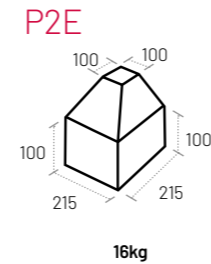

## Lintel Units

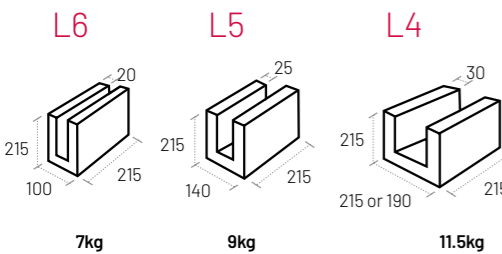

## Bond Beam Units

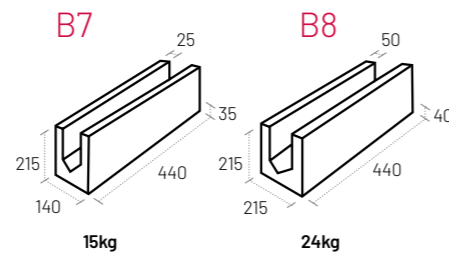

## Plinth Block

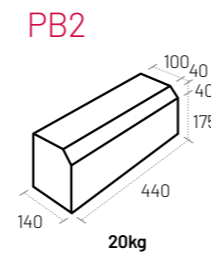

▼ Product: Colinwell Split Face Masonry  
Colour: Sandstone



# Split Face Masonry

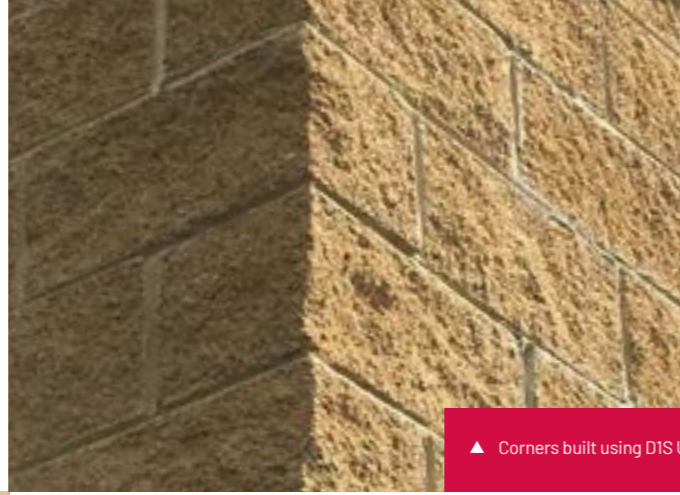

▲ Corners built using D1S Unit



▲ Corners built using F15 Unit

## Split Face Quoin & Corner Special

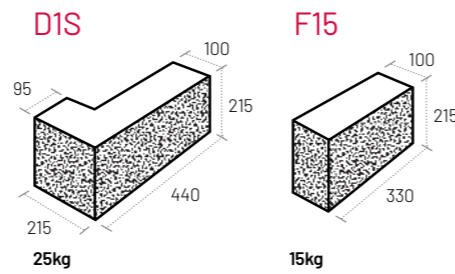

## Split Face Block

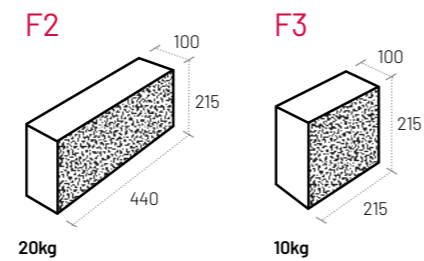

# Sound Absorbing Masonry

▲ Product: Colinwell Acousta Tex  
Colour: Whinstone and Portland



▲ Product: Colinwell Split Face Masonry  
Colour: Whinstone





# Acousta Tex

Sound Absorbing Masonry

Colinwell Acousta Tex Block is expertly manufactured using selected sound-porous aggregates combined with a specially developed sound-absorbing texture. These features give the blocks exceptional sound control qualities, making them ideal for environments where noise reduction is critical.

Acousta Tex Blocks effectively reduce sound reverberation, enhancing acoustic comfort and clarity within a space.



## Sound Absorption Coefficient

Wall Finish	Sound Frequency					
	125Hz	250Hz	500Hz	1000Hz	2000Hz	4000Hz
Colinwell Acousta Tex Block	0.37	0.62	0.48	0.49	0.55	0.57

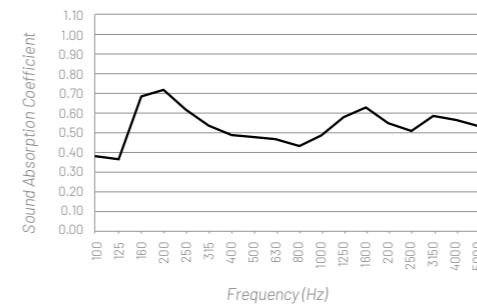

AT100

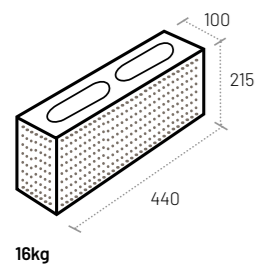

AT140

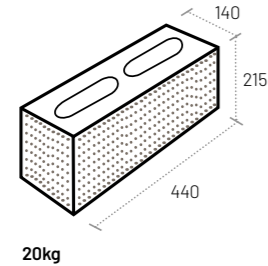

AT215

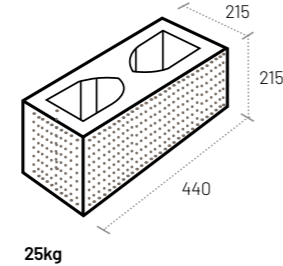

## Acousta Tex Colour Swatches



Cream



Green



Sandstone



Portland



Natural



White



Straw



Bracken

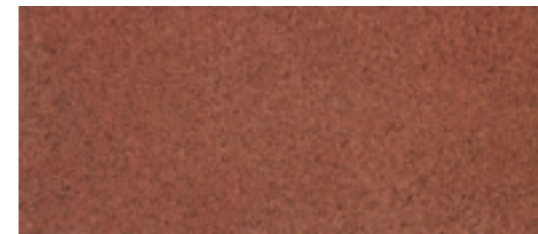

Red

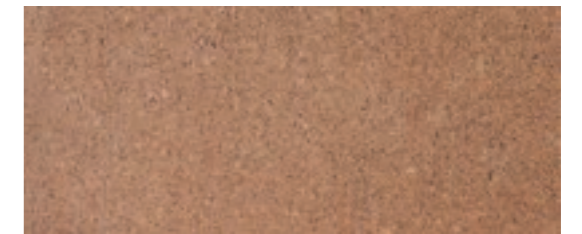

Honey

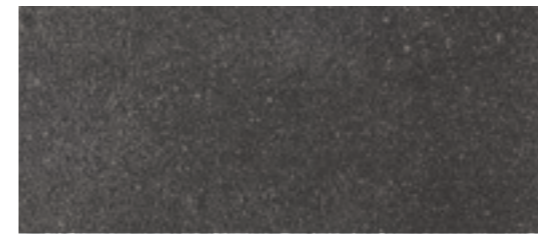

Whinstone



Buff

# Technical Information & Installation Guidance

▲ Product: Acousta Tex  
Colour: Straw



▲ Product: Colinwell Split & Smooth Face Masonry  
Colour: Sandstone

# Why Choose Colinwell Masonry Block?

## Durability You Can Trust

Colinwell Masonry blocks are engineered to withstand the elements, with integral waterproofing and frost resistance that ensures a clean, fresh appearance for decades.

## Versatile & Robust

Suitable for both load-bearing and non-load bearing walls, both internally and externally - including cavity walls, party walls, partitions and boundary walls. Available in a range of sizes, weights and finishes to meet your architectural requirements.

## Acoustic Performance

Our masonry blocks provide excellent sound reduction thanks to their high density and engineered design helping create comfortable, quiet environments.

## Fire Resistant & Safe

Manufactured with non-combustible materials, Colinwell Masonry complies with fire safety standards to protect your building and occupants.

## Colour & Finish Options

Choose from a wide range of colours, including colour blend masonry, with surface textures like smooth, split, shot-blasted, and acoustic finishes, allowing your project to stand out.

## Certified Quality

Produced under strict Quality Assurance standards (BS EN 9001) and fully compliant with European masonry standards (BS EN 771.3). Drying shrinkage and water absorption are kept to industry-leading low levels.

## Easy Installation & Design Flexibility

Blocks come with sharp arises, consistent dimensions, and compatible specials such as quoins, cills, and lintels, allowing smooth integration into your build.

# Colinwell Masonry Block Technical Specifications

## Product Composition & Manufacturing

- Manufactured from cement, specially graded aggregates, integral waterproofer, and pigment.
- Compacted under high pressure, cured with controlled heat and steam, resulting in efflorescence-free blocks.
- Quality assured under BS EN 9001.
- Compliance with BS EN 771-3, BS EN 772-4, and manufactured to tolerance category D2 under BS EN 771-5:2003.

## Physical Properties

- Drying shrinkage: < 0.04%.
- Water absorption: < 6%.
- Average density: 2100 kg/m<sup>3</sup>.
- Strength: Standard blocks > 15 N/mm<sup>2</sup> (higher strengths available on request).
- Shear bond strength: 0.15 N/mm<sup>2</sup> (per Annex C, BS EN 998-2).

## Fire Performance

- Non-combustible, will not contribute to flame spread.
- Aggregates used are Class 1 (White, Portland, Cream, Green, Sandstone) or Class 2 (all other colours).
- Fire resistance details per BS 5628 Part 3 available from Technical Department.

## Sizes & Finishes

- Block size: Metric 440 x 215 mm.
- Available finishes: Smooth, Split, Shotblasted, Acoustic Texture.
- Block types: Solid (unperforated), Cellular, Hollow.
- Specials: Half blocks, quoins/cavity closers, squints, cills, lintel and bond-beam blocks.

## Applications

- Suitable for internal and external load bearing and non-load bearing walls.
- Can be used below damp proof course (DPC).
- Suitable for reinforced masonry with bed joint reinforcement or concrete cores.

## High Density Sound Reduction

Colinwell Masonry's high density contributes to excellent sound insulation. The average sound reduction index, measured over a frequency range of 100–3150 Hz, is in line with the Mass Law Principle for plain masonry units.

## Sound Insulation (dB)

Block Thickness	100mm	140mm	215mm
Solid (Fair Face)	48	52	—
Cellular (Fair Face)	46	50	—
Hollow (Fair Face)	—	49	53
2 x 100mm leaves*(Fair Face)	55	—	—

## Thermal Efficiency

With an average density of 2100kg/m<sup>3</sup> and moisture-adjusted thermal conductivity values (k-values) of 1.35 W/m<sup>2</sup>°C for external walls and 1.25 W/m<sup>2</sup>°C for internal walls, Colinwell Masonry contributes to energy-efficient building envelopes.

## Construction & Installation Guidelines

- Recommended mortar mix: 1:1:6. cement:lime:sand, waterproofed and tinted to match or contrast block colours.
- Control joints spacing: 6–10 meters (consult Technical Department for specifics).
- Mortar finishing: Pole or bucket handle jointing preferred for appearance.
- Blocks should be laid randomly from at least 3 cubes/bales to avoid colour banding.
- Surplus mortar must be removed immediately to prevent staining.
- Include recommended mortar to compliment masonry colours.



▲ Product: Colinwell Split Face Masonry  
Colour: Portland

## Technical Information

### Handling & Storage

Care should be taken to avoid damage to block surfaces. Blocks should ideally be off-loaded and positioned mechanically. Protect all units from rain and dirt during storage. We recommend handling blocks using pallets and moving them with a forklift, telehandler, or similar equipment. Colinwell can provide pallets upon request, but they are not supplied as standard.

### Packing

Blocks are packed in cubes and protected with plastic covers.

### Distribution & Supply

Colinwell Masonry is available for direct order. Delivery typically begins approximately three weeks from receipt of written order, aligned with an agreed programme.

### Maintenance

Colinwell Masonry requires no initial surface treatment. Once installed, the blocks are maintenance free aside from occasional washing, if desired. The appearance of external walls will naturally improve with age, offering long-term aesthetic value.

## How to specify

NBS Model Specification, F10 Block Walling 250A  
Concrete Facing Blockwork.

The Architectural Masonry blocks for (project name and location).

Manufacturer of Colinwell Masonry: Colinwell Masonry Products Ltd,  
37 Colinglen Road, Dunmurry, Belfast, BT17 0LP, Tel: 028 9061 8155  
Email: info@colinwell.com.

Masonry shall be cured by steam to give the blocks efflorescence free performance characteristics, have a maximum moisture movement of 0.15mm/m and comply with BS EN 771-3 and BS 5628-1.

Mean compressive strength of all masonry blocks shall be 10.5N/mm<sup>2</sup>.

Water Absorption not to exceed 3% to 6%.

Average K value shall be 1.28W/m<sup>2</sup>C.

Density shall be 2100kg/m<sup>3</sup>.

Size is to be: indicate 440mm x width (from options listed below) x 215mm standard metric.

(insert one of the following in widths 100mm, 140mm, 215mm).

Type of unit to be: (solid, cellular or hollow).

Surface texture to be: (smooth, split, shot blasted, acoustic).

Colour(s) to be: (selected from selector section).

Specials required: (indicate from specials selector section).

Custom made specials to my own design(s), size(s) required. See the drawings attached to this specification.

Mortar mix: (e.g. 1:1:6).

Mortar colour: (e.g. cream G89).

Joint: (e.g. bucket handle / pole).



▼ Product: Colinwell Smooth Face Masonry  
Colour: Natural

# Paint Grade Masonry

▲ Product: Colinwell Paint Grade Masonry  
(Painted White)



## Colinwell Paint Grade Masonry

Colinwell Paint Grade Masonry is a practical and economical solution for internal and external walling where a painted finish is desired. Offering excellent fire resistance, sound insulation, and load-bearing performance, it's ideal for use on the internal leaf of cavity walls, external cavity leaves when coated with masonry paint, partition walls, or as backup for curtain walling systems. Suitable across a wide range of applications from domestic builds to industrial, commercial and even high-profile architectural projects.

▲ Product: Colinwell Paint Grade Masonry (Painted White)



▲ Product: Colinwell Paint Grade Masonry (Painted Red)

### Composition & Quality

Manufactured from a carefully controlled mix of aggregates and cement, Colinwell Paint Grade Masonry complies with BS EN 771-3 and meets all relevant Building Regulations.

### Coverage

Block size: 450 x 225mm.  
Coverage: 10 blocks per m<sup>2</sup>.

### Compressive Strength

Standard: 10.4 N/mm<sup>2</sup>.  
Higher strengths available: Up to 35 N/mm<sup>2</sup> (upon request).

### Appearance & Finish

Each unit is produced to tight dimensional tolerances with sharp, clean arrises and low moisture absorption. The aggregate texture is specifically selected to provide an ideal surface for painting.

Please note: as Paint Grade blocks are stocked items, colour consistency cannot be guaranteed unless blocks are ordered as a single production batch.

### Thermal Conductivity

Average Density: 2100 kg/m<sup>3</sup>.  
Moisture Content: 5% (external), 3% (internal).

### Thermal Conductivity (k value):

External leaf: 1.35 W/m°C.  
Internal leaf: 1.25 W/m°C.

### Air Tightness

Colinwell Paint Grade Blocks contribute significantly to reducing air permeability, helping projects meet the latest Part L requirements of the Building Regulations. When used in the internal leaf of a cavity wall, these blocks improve a building's thermal efficiency and help minimise energy consumption.

Independently tested by BSRIA, Colinwell Paint Grade Blocks return excellent results in air leakage performance.

Contact our Technical Department for certification or detailed test data.

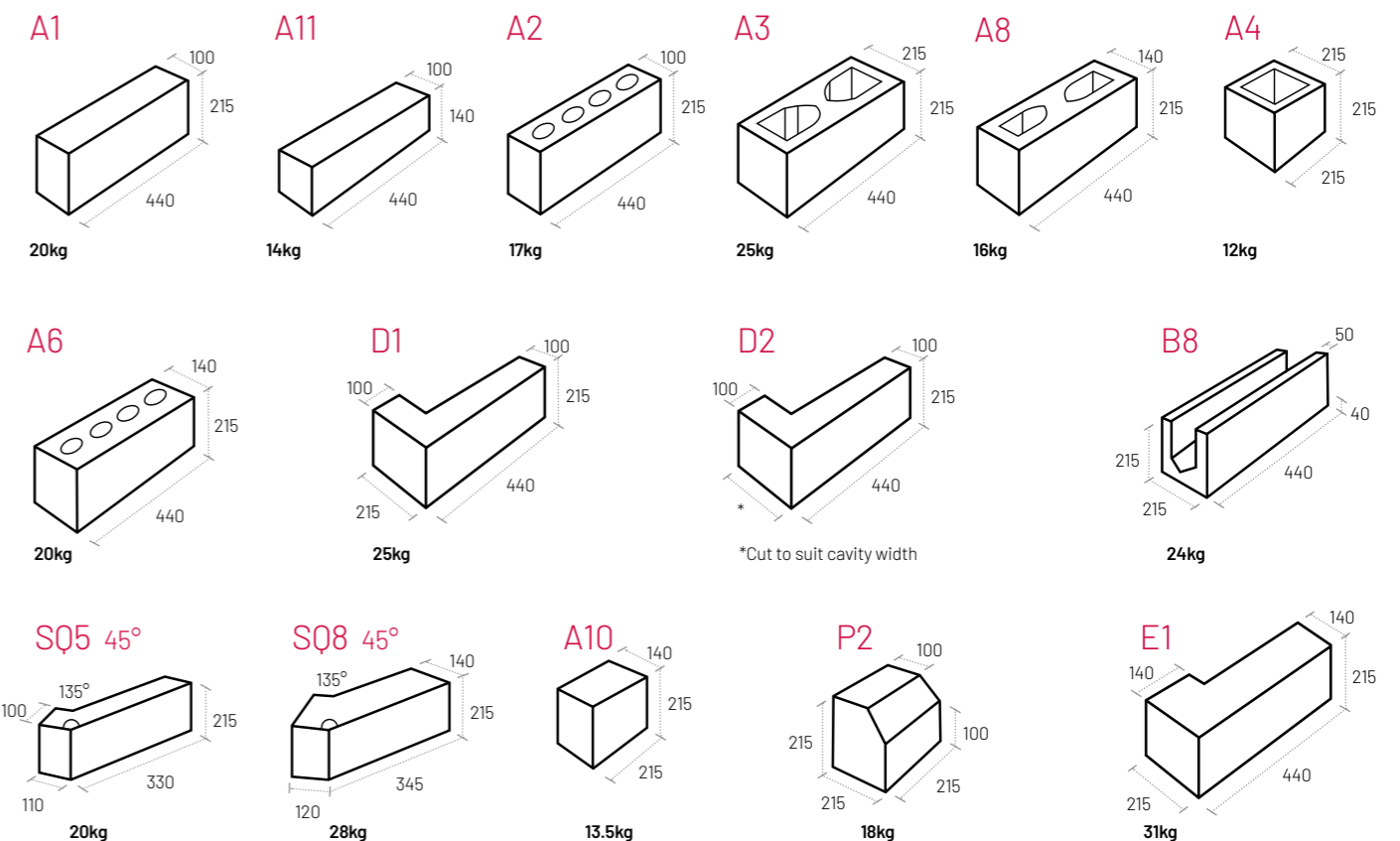

100mm thick Squints are also available in 60° (120°) and 30° (150°) options.

## How to specify

NBS Model Specification, F10 Block Walling 255  
Concrete Facing Blockwork.

The Paint Grade blocks for (project name and location).

Manufacturer of Colinwell Masonry: Colinwell Masonry Products  
Ltd, 37 Colinglen Road, Dunmurry, Belfast, BT17 OLP, Tel: 028  
9061 8155 Email: info@colinwell.com.

Paint Grade blocks shall comply with BS EN 771-3 and  
BS 5628-1 and have a mean compressive strength of 10.5N/mm<sup>2</sup>.

Average K value shall be 1.25W/m<sup>2</sup>C.

Density shall be 2100kg/m<sup>3</sup>.

Size is to be: indicate 440mm x width (from options  
listed below) x 215mm.

(insert one of the following in widths: 100mm, 140mm, 215mm).

Type of unit to be: (solid, cellular or hollow).

Specials required: (indicate from specials selector section).

Mortar mix: (e.g. 1:1:6).

Joint: (e.g. bucket handle / pole).

NBS Specs and Bim objects available online.

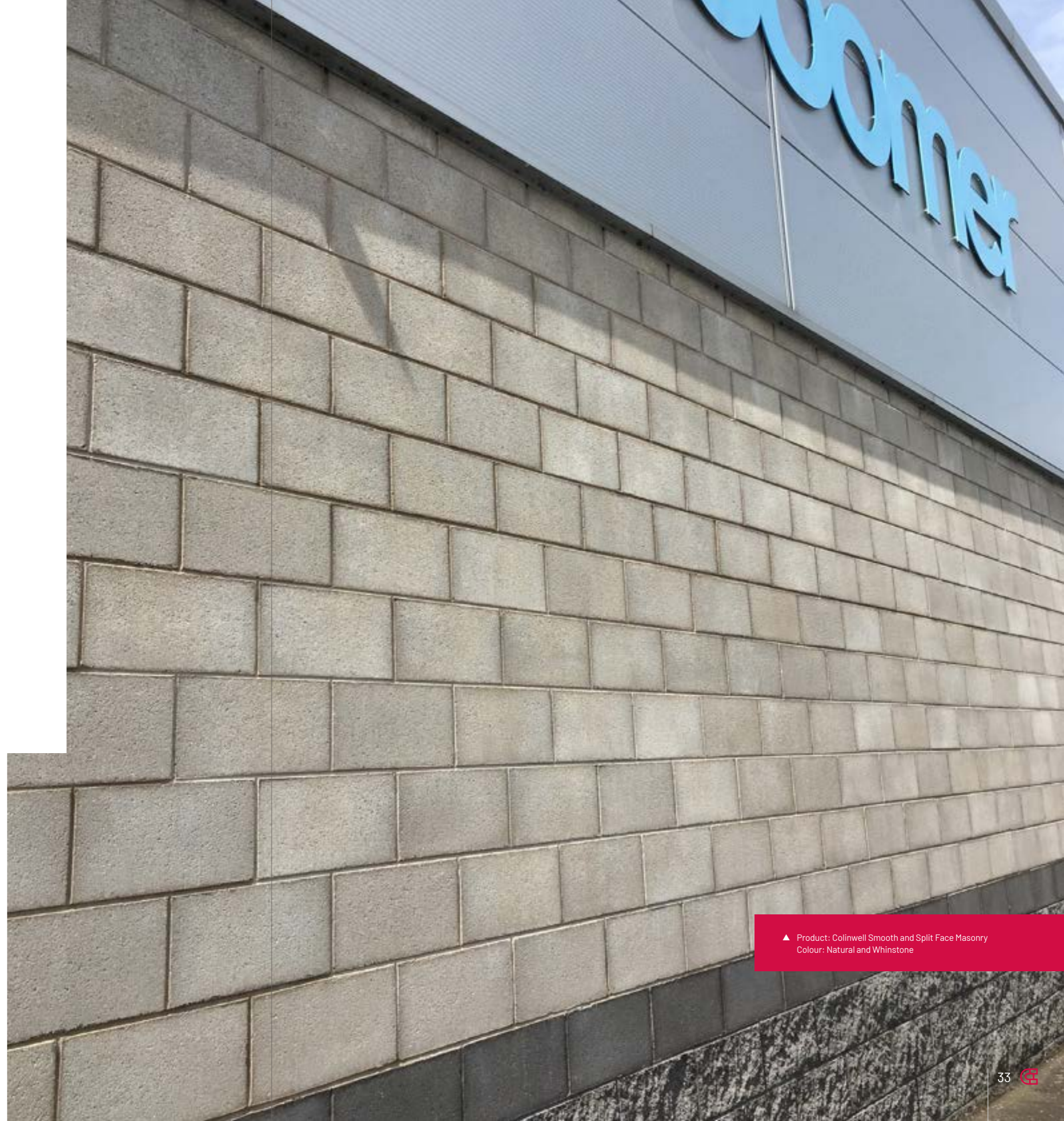

▲ Product: Colinwell Smooth and Split Face Masonry  
Colour: Natural and Whinstone



▲ Product: Colinwell Split Face Masonry  
Colour: Straw and Whinstone

## Our Accreditations



Colinwell proudly holds Level 2+ Accreditation in Factory Production Control from the NSAI (National Standards Authority of Ireland). This certification supports our commitment to quality and consistency across our supply chain in the Republic of Ireland.



We are dedicated to delivering high quality products, exceptional service, and customer satisfaction. To support this commitment, we have developed robust Quality Management Systems, which have earned us the internationally recognised ISO 9001 Quality Management Accreditation.



Colinwell takes environmental responsibility seriously. Our materials have contributed to the construction of numerous landmark projects throughout the UK and Ireland. As part of our commitment to sustainable business practices, we hold ISO 14001 Environmental Management Certification - reflecting our efforts to minimise environmental impact and support future generations.



Colinwell's Architectural Masonry carries CE Marking, demonstrating compliance with EU legislation and confirming that our products meet all applicable European health, safety, and environmental protection standards.



**Colinwell**

37 Colinglen Road, Dunmurry  
Belfast, BT17 0LP

**Contact Us**

[www.colinwell.com](http://www.colinwell.com)  
[info@colinwell.com](mailto:info@colinwell.com)  
Northern Ireland: 028 9061 8145  
Ireland: 00353 1 906 1801  
England: 0113 350 0880  
Scotland: 0141 319 4759

**Colinwell**   
**Masonry & Retaining Wall Products**